

TOYOTA RAV4

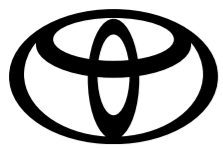

**BE PART OF THE
ADVENTURE**





SPECIFICATIONS

	RAV4 2.0 VX	RAV4 2.5 HEV GX	RAV 2.5 HEV GR-S	RAV4 2.5 HEV VX
--	-------------	-----------------	------------------	-----------------

Engine and Drivetrain

Bore x Stroke (mm)	80.5x97.62	87.5x103.48	87.5x103.48	87.5x103.48
Engine capacity (litre)	2.0	2.5	2.5	2.5
Fuel System	Petrol	Petrol Hybrid	Petrol Hybrid	Petrol Hybrid
Maximum Power (kW @ r/min)	127 @ 6600	137 @ 6000	137 @ 6000	137 @ 6000
Maximum Torque (Nm @ r/min)	203 @ 4400-4800	221 @ 3600-5200	221 @ 3600-5200	221 @ 3600-5200
Number of Cylinders and Arrangement	Inline-4	Inline-4	Inline-4	Inline-4
Sequential shift
Electric Motor Power (kW)		Front 100 Rear 39.9	Front 100 Rear 39.9	Front 100 Rear 39.9
Electric Motor Torque (Nm)		Front 208 Rear 121	Front 208 Rear 121	Front 208 Rear 121
Total System Output (kW)		176	176	176
Fuel Consumption (Combined Cycle) (l/100km)	6.3	4.5	4.7	4.5
CO2 Emission (g/km)	143	102	107	102

Transmission

Transmission	CVT	CVT	CVT	CVT
Driven Wheels	FWD	AWD E-FOUR	AWD E-FOUR	AWD E-FOUR
Starting System	Push Start	Push Start	Push Start	Push Start
Paddle Shift			.	

Suspension

Front	MacPherson	MacPherson	GR-S MacPherson	MacPherson
Rear	Wishbone---Trailing	Wishbone---Trailing	GR-S-Wishbone---Trailing	Wishbone---Trailing

Wheels and Tyres

Spare Wheel	Full 235-60R18 Alloy	Full 235-60R18 Alloy	Space Saver 165-90D18 Steel	Full 235-60R18 Alloy
Tyre Size	F:235-60R18 Alloy- R:235-60R18 Alloy	F:235-60R18 Alloy- R:235-60R18 Alloy	F:235-50R20 Alloy- R:235-50R20 Alloy	F:235-60R18 Alloy- R:235-60R18 Alloy

Body and Styling

Body Colour	Monotone	Monotone	Two tone	Monotone
Daytime Running Light
Door Outside Handles	Colour - Coded	Colour - Coded	Colour - Coded	Colour - Coded
Front Bumper	Black + Colour Coded	Black + Colour Coded	GR-S Black	Black + Colour Coded
Front Fog Lamps	Standard LED	Standard LED	Standard LED	Standard LED
Front Window Wiper	Auto, Rainsensing	Intermittent, Time adjustable	Auto, Rainsensing	Auto, Rainsensing
Headlamp Levelling	Standard Automatic	Standard Manual	Standard Automatic	Standard Automatic
Headlights	LED - Adaptive High-beam System (AHS)	LED	LED	LED - Adaptive High-beam System (AHS)
Light Control System
Luggage Boot / Rear Door	Standard Power	Standard Manual	Standard Power	Standard Power
Rear Bumper	Black - Skid Plate	Black	Black - Skid Plate	Black - Skid Plate

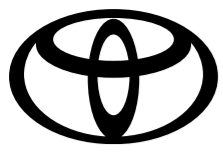

SPECIFICATIONS

RAV4 2.0 VX

RAV4 2.5 HEV GX

RAV 2.5 HEV GR-S

RAV4 2.5 HEV VX

Body and Styling

Rear Fog Lamp	Standard LED	Standard LED	Standard LED	Standard LED
Rear Lights	LED	LED	LED	LED
Side mirrors	Black, Power, Auto-Retractable, With Indicator, Blind Spot Monitor (BSM), Heated, Camera, Foot light	Black, Power, With Indicator, Heated	Black, Power, Auto-Retractable, With Indicator, Blind Spot Monitor (BSM), Heated, Camera, Foot light	Black, Power, Auto-Retractable, With Indicator, Blind Spot Monitor (BSM), Heated, Camera, Infrared (IR), Foot light
Rear Spoiler
Roof Rails

Interior, Comfort and Convenience

Cupholders	Standard 4	Standard 4	Standard 4	Standard 4
Door Inside Handles	Gun Metal	Gun Metal	Gun Metal	Gun Metal
Floor Carpet Trim	Carpet With Heel Pad	Carpet With Heel Pad	Carpet With Heel Pad	Carpet With Heel Pad
Front Personal Lamp	Standard LED	Standard LED	Standard LED	Standard LED
Luggage Room Lamp	Standard LED	Standard LED	Standard LED	Standard LED
Overhead Console	Standard, Sunglass Holder	Standard, Sunglass Holder	Standard, Sunglass Holder	Standard, Sunglass Holder
Package trim and Tonneau cover
Rear View Mirror	Digital	Day & Night	Digital	Digital
Room Lamp	Standard LED	Standard LED	Standard LED	Standard LED
Seat Back Pockets	Standard Driver and Passenger	Standard Driver and Passenger	Standard Driver and Passenger	Standard Driver and Passenger
Seat Trim	Leather	Fabric	GR Sport Leather Sporty	Leather
Shift Lever & Knob	Leather	Urethane	GR-S Leather	Shift by wire With Integrated Parking
Steering Wheel	3 Spoke Leather	3 Spoke Urethane	3 Spoke Heated, GR-S Leather	3 Spoke Leather
Airconditioner	Auto Dual zone	Auto Dual zone	Auto Dual zone	Auto Dual zone
Android Auto & Apple CarPlay
Audio System	JBL Display Audio, 12.9-inch	Toyota Display Audio, 10.5-inch	JBL Display Audio, 12.9-inch	JBL Display Audio, 12.9-inch
Bluetooth
Cruise Control	Standard Adaptive, All Speed	.	Standard Adaptive, All Speed	Standard Adaptive, All Speed
Electric Windows	All All One Touch	All All One Touch	All All One Touch	All All One Touch
Front Seat Adjustment	Driver & Passenger Power/ Driver Memory	Driver Power & Passenger Manual	Driver & Passenger Power	Driver & Passenger Power/ Driver Memory
Heads Up Display (HUD)
Illuminated Entry
Light Remind Warning
Multi-Information Display	Standard 12.3-inch	Standard 12.3-inch	Standard 12.3-inch	Standard 12.3-inch
Navigation System
Power Socket	Front - 12V / Rear - 12V	Front - 12V / Rear - 12V	Front - 12V / Rear - 12V	Front - 12V / Rear - 12V

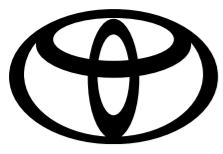

SPECIFICATIONS

RAV4 2.0 VX

RAV4 2.5 HEV GX

RAV 2.5 HEV GR-S

RAV4 2.5 HEV VX

Interior, Comfort and Convenience

Power Steering	Electric / (EPS)	Electric / (EPS)	Electric / (EPS)	Electric / (EPS)
Rear Armrest	Standard 2 Cupholders	Standard 2 Cupholders	Standard 2 Cupholders	Standard 2 Cupholders
Reverse Camera	Display Audio/ Panoramic View Monitor	Display Audio	Display Audio/ Panoramic View Monitor	Display Audio/ Panoramic View Monitor
Seat Heater	Standard Front and Rear		Standard Front	Standard Front and Rear
Seat Lumbar Support	Power, Driver	Power, Driver	Power, Driver	Power, Driver
Seat Ventilation	Standard Front only			Standard Front only
Speakers	Standard 9	Standard 6	Standard 9	Standard 9
Steering Switches	Standard Audio, Info Display, Voice Command, Lane Departure Alert, Adaptive Cruise Control	Standard Audio, Info Display, Voice Command	Standard Audio, Info Display, Voice Command, Lane Departure Alert, Adaptive Cruise Control	Standard Audio, Info Display, Voice Command, Lane Departure Alert, Adaptive Cruise Control
Toyota Connect Enabled
USB Type C	Standard 5PCs	Standard 5PCs	Standard 5PCs	Standard 5PCs
Wireless Charger	Standard Front x1		Standard Front x1	Standard Front x1

Safety and Security

Airbag On-Off Switch
Airbags	Driver, Passenger, Driver Knee, Front Side, Rear Curtain, Front Curtain	Driver, Passenger, Driver Knee, Front Side, Rear Curtain, Front Curtain	Driver, Passenger, Driver Knee, Front Side, Rear Curtain, Front Curtain	Driver, Passenger, Driver Knee, Front Side, Rear Curtain, Front Curtain
Anti-Theft System	Immobiliser Alarm	Immobiliser Alarm	Immobiliser Alarm	Immobiliser Alarm
Auto Door Lock
Child Lock
Child Restraint System (ISOFIX)	Standard 2	Standard 2	Standard 2	Standard 2
Front Brake	Ventilated Disc	Ventilated Disc	Ventilated Disc	Ventilated Disc
Over-Run and Speed Limiter	.			
Parking Brake	Electric	Electric	Electric	Electric
Pre-Crash System (Brake Synchronised)	.		.	.
Rear Brake	Disc	Disc	Disc	Disc
Seat Belt Warning	Front + Rear	Front + Rear	Front + Rear	Front + Rear
Toyota Safety Sense	.		.	.
Wireless Door Lock	Standard Smart Entry	Standard Smart Entry	Standard Smart Entry	Standard Smart Entry

Driver Support Systems

Anti-Lock Braking System (ABS)
Blind Spot Monitor (BSM)	Standard Safe Exit Assist		Standard Safe Exit Assist	Standard Safe Exit Assist
Brake Assist (BA)
Drive Mode Select	Standard Eco / Normal / Sport / Trail / Snow	Standard Eco / Normal / Sport / Trail / Snow	Standard Eco / Normal / Sport / Trail / Snow	Standard Eco / Normal / Sport / Trail / Snow
Electronic Brake Force Distribution (EBD)
Hill Assist Control (HAC)

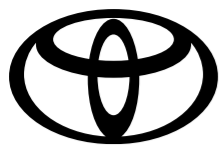

SPECIFICATIONS

RAV4 2.0 VX

RAV4 2.5 HEV GX

RAV 2.5 HEV GR-S

RAV4 2.5 HEV VX

Driver Support Systems

Lane Keeping System	Standard Lane Trace Assist		Standard Lane Trace Assist	Standard Lane Trace Assist
Limited Slip Differential	.			
Park Distance Control	Standard Front + Rear, Intelligent Clearance Sonar	Standard Front + Rear	Standard Front + Rear, Intelligent Clearance Sonar	Standard Front + Rear, Intelligent Clearance Sonar
Road Sign Assist	.		.	.
Vehicle Stability Control (VSC)
Downhill Assist Control (DAC)		.	.	.
Intelligent Park Assist				.

Service and Warranty

Service Interval	12 months / 15,000km	12 months / 15,000km	12 months / 15,000km	12 months / 15,000km
Service Plan	6 Services / 90,000km	6 Services / 90,000km	6 Services / 90,000km	6 Services / 90,000km
Warranty	3 years / 100,000km	3 years / 100,000km	3 years / 100,000km	3 years / 100,000km
Hybrid Battery Warranty		8 years 160,000km	8 years 160,000km	8 years 160,000km

Dimensions and Capacities

Front Overhang (mm)	920	920	955	920
Front Tread (mm)	1600	1600	1620	1600
Fuel Tank Size (L)	55	55	55	55
Gross Combination Mass (GCM)	3115	3230	3230	3230
Gross Vehicle Mass (GVM)	2115	2230	2230	2230
Ground Clearance (mm)	201	201	186	201
Height (mm)	1695	1695	1680	1695
Kerb Weight (kg)	1600-1615	1695-1710	1725-1740	1720-1775
Length (mm)	4600	4600	4645	4600
Luggage Capacity (L)	688	705	732	688
Rear Overhang (mm)	990	990	1000	990
Rear Tread (mm)	1625	1625	1650	1625
Towing Capacity - Braked (kg)	1000	1000	1000	1000
Towing Capacity - Unbraked (kg)	750	750	750	750
Turning circle (tyres, m)	5.6	5.6	5.6	5.6
Wheelbase (mm)	2690	2690	2690	2690
Width (mm)	1855	1855	1880	1855
Top Speed (km/h)	190	180	180	180

LINE DRAWING

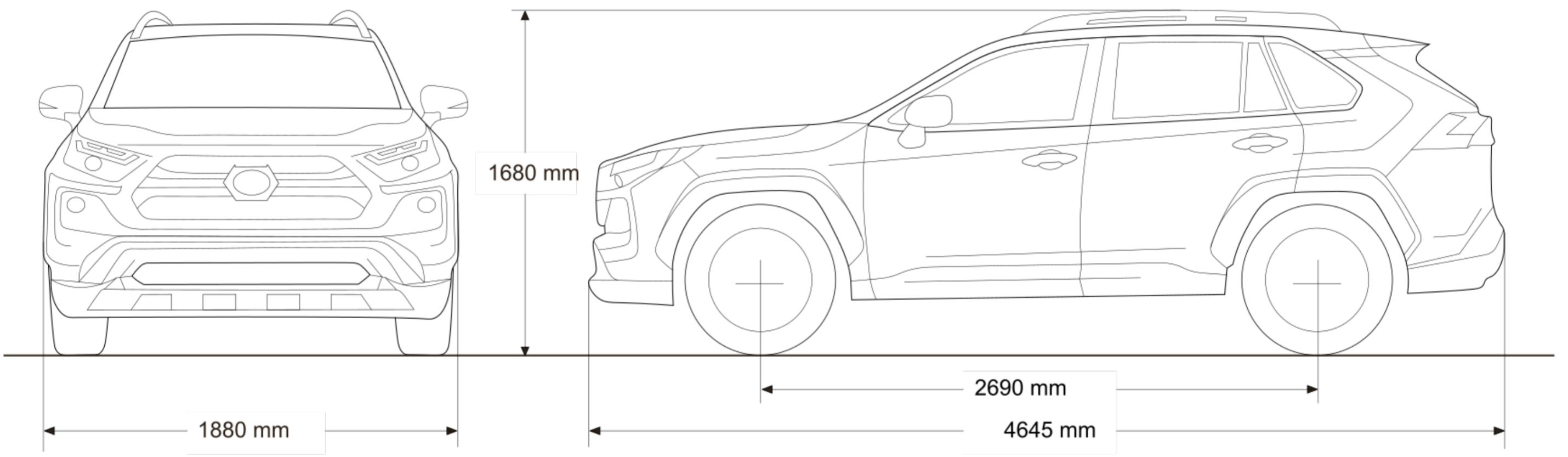

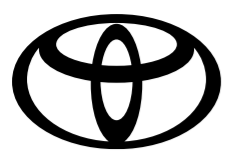

SPECIFICATIONS

EXTERIOR COLOURS

MONOTONE



089 - Platinum White Pearl



218 - Attitude Black



6X7 - Midnight Green



1M6 - Moon Grey



1L6 - Smokey Blue

BI-TONE



2TB - Passion Red Bi-Tone



M38 - Moon Grey Bi-Tone



M22 - Smokey Blue Bi-Tone



2VP - Platinum White Bi-Tone

Disclaimer:

For illustrative purposes only.

Please Note: Monotone available on GX and VX models. BiTone available on GR-S models.

SPECIFICATIONS

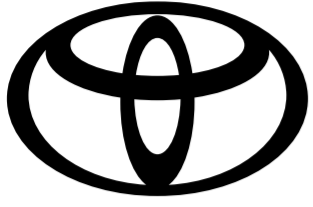

Disclaimer:

The information contained within or made available on any Toyota platform or note including but not limited to, this website/brochure/specification sheet, is provided for information purposes only. While we make reasonable efforts to update the information on our platform/s, Toyota Motor Corporation of Japan, and Toyota South Africa Motors (Pty) Ltd makes no representations, warranties, or guarantees, whether express or implied, that the content is accurate, complete or up to date, and all information contained herein is subject to change without notice.

Vehicle specifications may vary depending on the model, trim level, and market. Colours depicted on print and web material may not match the actual vehicle colour. Fuel consumption figures are estimates based on standardised testing conditions and actual results may vary due to (but not limited to) driving style, vehicle loading, tyres, wind, traffic, and accessories. All dimensions, capacities, and performance figures are approximate. Some features/options may be optional or only available on certain models/trim levels. Images and illustrations are for illustrative purposes only and may not reflect the actual vehicle.

Your use of, or reliance on, any information or contents herein is entirely at your own risk. Toyota Motor Corporation of Japan and Toyota South Africa Motors (Pty) Ltd (including its owners, agents, consultants, employees, and any affiliated person(s)) are not responsible for any loss or damages related to your use of, reliance on, or understanding of any information or contents on this or any other Toyota platform. This includes, without limitation, any direct, indirect, special, incidental, consequential, or punitive damages in terms of any contract, delict (breach of a duty of care) or law.

Furthermore, Toyota Motor Corporation of Japan and Toyota South Africa Motors (Pty) Ltd do not guarantee the uninterrupted or error-free operation of any platform or the availability of content, and are not liable for any interruptions, errors, or damages caused by any technical issues or limitations of these platforms, including but not limited to, server downtime, software malfunctions, or internet connectivity issues.

